

Two Way Two Position (Poppet-type)

BST12-221

Normally Open

Description of the process

When energized, the valve acts as a check valve, allowing flow from ① to ②, while blocking flow from ② to ①; When de-energized, allowing flow from ② to ①, while ① to ② is severely restricted. To override, push button and remain, the valve blocking flow from ② to ①; Release the button, then the valve allowing flow from ② to ①.

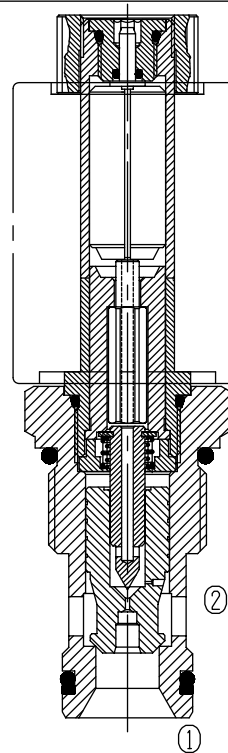

Specifications:	250bar
Max. Working Pressure	See Performance
Flow Max.	0.3ml/min at 210bar
Internal Leakage	5drops/min
Operating Volt	12VDC, 24VDC, 110VAC, 220VAC
Min Voltage Requires	85% of normal voltage
Filtration Of Oil	20μm or better
Type of Standard Cavity	T6-1
Temperature	-30~+100℃ Standard Buna Seals
Standard Block Model	T6-11*/13*/14*/16*

Symbol:

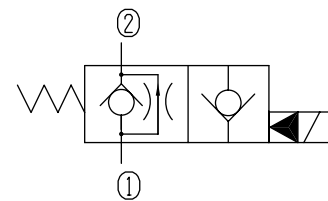

Characteristic: 32 cST Oil/40°C

② — ① — (d)
① — ② — (e)

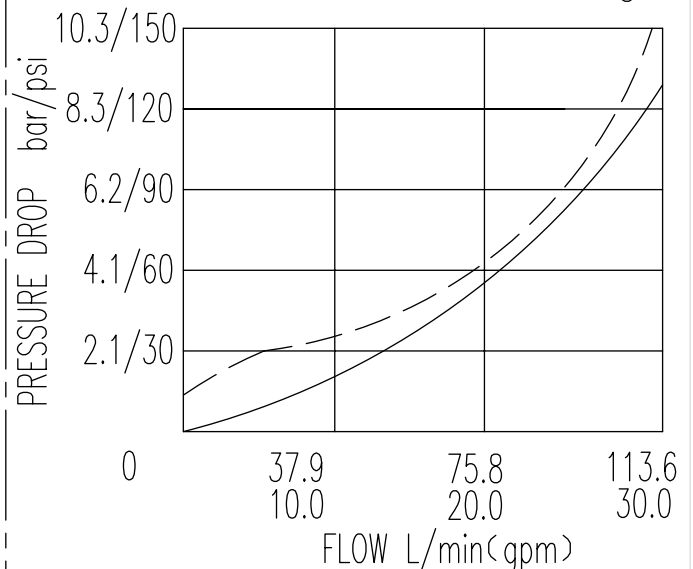

Two Way Two Position (Poppet-type)

BST12-221 Normally Open

Profile dimensions

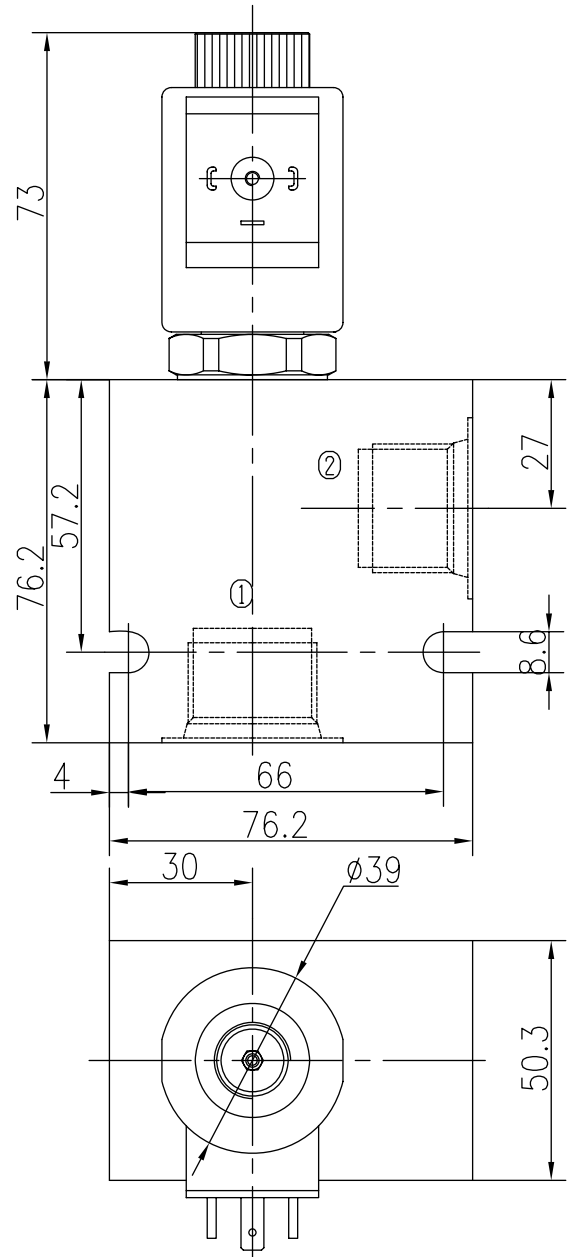
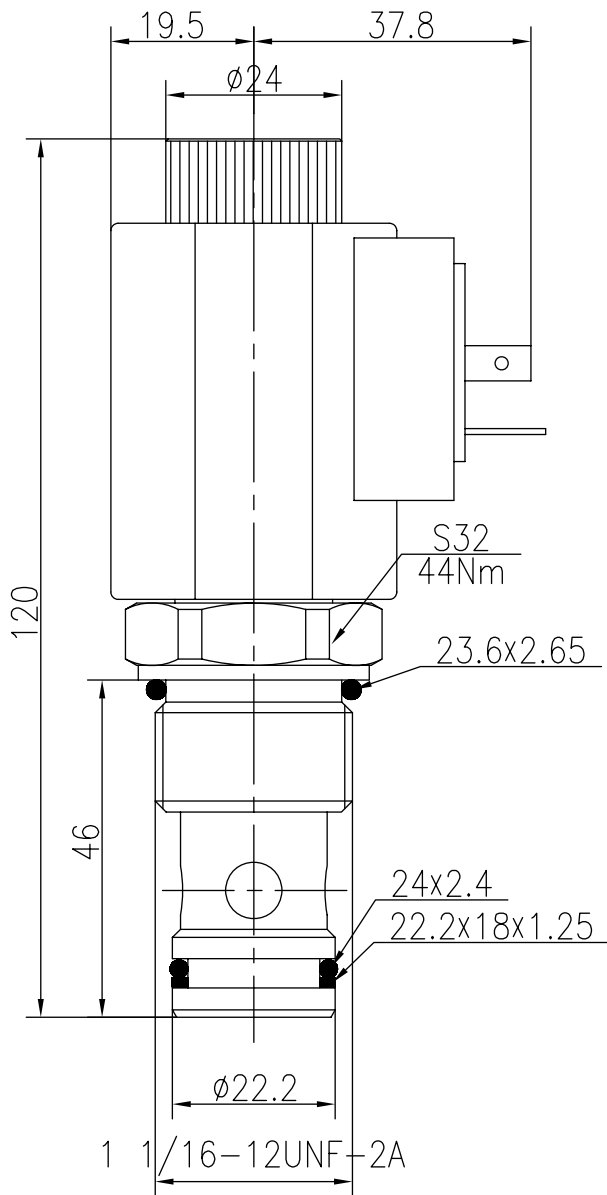

TO ORDER

BST12-221

Solenoid Valve
Function

Body Porting

Omit for Cartridge only

G3/4 5G
G1 6G
SAE10 10T
SAE12 12T

Seals

Buna(Std.) N

Fluorocarbon V

Voltage

12 12VDC
24 24VDC
110 110VAC
220 220VAC

Connection

DL Double Leads

DH Electrical Outlet